

NEMA Standards Publication GR 1-2017

Ground Rod Electrodes and Ground Rod Electrode Couplings

Published by

National Electrical Manufacturers Association

1300 North 17th Street, Suite 900

Rosslyn, Virginia 22209

www.nema.org

© 2017 National Electrical Manufacturers Association. All rights, including translation into other languages, reserved under the Universal Copyright Convention, the Berne Convention for the Protection of Literary and Artistic Works, and the International and Pan American copyright conventions.

NOTICE AND DISCLAIMER

During the development of this standard, the persons engaged in reaching consensus could not achieve consensus about what to name specific nominal trade size designations for zinc-coated ground rods in Tables 3.1, 3.2 and 6.1. A review during an appeal determined that the inability to achieve consensus was attributable to a commercial and competitive disagreement among manufacturers. The appeals decision directed that trade size designations for zinc-coated, copper-bonded, and stainless-steel ground rods be treated with consistency within the standard. When consensus could not be achieved again following the appeal, the Executive Committee of the NEMA Board of Governors resolved the disagreement by approving the nominal trade size designations shown in the “trade size” column in each of these three tables, and further directed, at the recommendation of NEMA’s Codes & Standards Committee, that the foreword of this standard bring to the reader’s attention the history of these changes to minimize potential confusion. Accordingly, Table 3.1 identifies zinc-coated ground rods of different dimensions by their finished mean diameter and the minimum and maximum diameters for a given “trade size” of zinc-coated ground rod. Table 3.2 contains corresponding dimensions for the end point configurations for each trade size, and Table 6.1 recites application diameters for threadless couplings for each trade size of zinc-coated ground rod. In addition to the information in the foreword and the standard, the user is encouraged to consult with the manufacturer about couplings and connectors to be used with specific grounding rods. In all other respects, the information in this publication was considered technically sound by the consensus of persons engaged in the development and approval of the document at the time it was developed. Consensus does not necessarily mean that there is unanimous agreement among every person participating in the development of this document.

The National Electrical Manufacturers Association (NEMA) standards and guideline publications, of which the document contained herein is one, are developed through a voluntary consensus standards development process. This process brings together volunteers and/or seeks out the views of persons who have an interest in the topic covered by this publication. While NEMA administers the process and establishes rules to promote fairness in the development of consensus, it does not write the document and it does not independently test, evaluate, or verify the accuracy or completeness of any information or the soundness of any judgments contained in its standards and guideline publications.

NEMA disclaims liability for any personal injury, property, or other damages of any nature whatsoever, whether special, indirect, consequential, or compensatory, directly or indirectly resulting from the publication, use of, application, or reliance on this document. NEMA disclaims and makes no guaranty or warranty, express or implied, as to the accuracy or completeness of any information published herein, and disclaims and makes no warranty that the information in this document will fulfill any of your particular purposes or needs. NEMA does not undertake to guarantee the performance of any individual manufacturer or seller’s products or services by virtue of this standard or guide.

In publishing and making this document available, NEMA is not undertaking to render professional or other services for or on behalf of any person or entity, nor is NEMA undertaking to perform any duty owed by any person or entity to someone else. Anyone using this document should rely on his or her own independent judgment or, as appropriate, seek the advice of a competent professional in determining the exercise of reasonable care in any given circumstances. Information and other standards on the topic covered by this publication may be available from other sources, which the user may wish to consult for additional views or information not covered by this publication.

NEMA has no power, nor does it undertake to police or enforce compliance with the contents of this document. NEMA does not certify, test, or inspect products, designs, or installations for safety or health purposes. Any certification or other statement of compliance with any health or safety–related information in this document shall not be attributable to NEMA and is solely the responsibility of the certifier or maker of the statement.

CONTENTS

	Foreword	v
Section 1	General	1
1.1	Scope.....	1
1.2	Normative References.....	1
1.3	Units Of Measurement.....	2
1.4	Definitions	2
Section 2	Copper-Bonded Ground Rod Electrodes	3
2.1	Steel Core Properties	3
2.2	Copper Thickness.....	3
2.3	Length.....	3
2.4	Ground Rod Electrode Diameters	3
2.5	Threads.....	4
2.6	End Configurations	4
2.7	Adhesion.....	5
	2.7.1 Test Method.....	5
	2.7.2 Evaluation of Adhesion.....	5
2.8	Ductility	6
	2.8.1 Test Method.....	6
	2.8.2 Evaluation of Ductility	6
2.9	Finish	6
2.10	Straightness.....	6
	2.10.1 Test Method.....	6
	2.10.2 Evaluation of Straightness.....	6
2.11	Markings	7
Section 3	Zinc-Coated Ground Rod Electrodes	8
3.1	Steel Core Properties	8
3.2	Zinc Coating.....	8

3.2.1	Coating Method	8
3.2.2	Thickness.....	8
3.2.3	Measurement.....	8
3.3	Length.....	8
3.4	Ground Rod Electrode Diameters	9
3.5	Adhesion.....	9
3.5.1	Test Method.....	9
3.5.2	Evaluation of Adhesion.....	10
3.6	Finish	10
3.7	Straightness.....	10
3.7.1	Test Method.....	10
3.7.2	Evaluation of Straightness.....	10
3.8	End Configurations	10
3.9	Markings	12
Section 4	Stainless Steel Ground Rod Electrodes.....	13
4.1	Steel Properties	13
4.2	Length.....	13
4.3	Ground Rod Electrode Diameters	13
4.4	Finish	13
4.5	Straightness.....	14
4.5.1	Test Method.....	14
4.5.2	Evaluation.....	14
4.6	End Configurations	14
4.7	Markings	15
4.8	Threads.....	15
Section 5	Couplings for Copper-Bonded Ground Rod Electrodes	16
5.1	Physical Properties.....	16
5.1.1	Surface Condition.....	16
5.1.2	Material.....	16

5.2	Construction.....	16
	5.2.1 Length.....	16
	5.2.2 Application Diameter	16
5.3	Performance	17
	5.3.1 Conductivity	17
	5.3.2 Impact.....	17
	5.3.3 Pullout.....	18
	5.3.4 Bend	18
	5.3.5 Mechanical Strength.....	18
5.4	Markings	18
Section 6	Couplings for Zinc-Coated Ground Rod Electrodes.....	19
6.1	Physical Properties.....	19
	6.1.1 Surface Condition	19
	6.1.2 Material.....	19
6.2	Construction.....	19
	6.2.1 Length.....	19
	6.2.2 Threadless Ground Rod Electrode Couplings.....	19
6.3	Performance	20
	6.3.1 Conductivity	20
	6.3.2 Impact.....	20
	6.3.3 Pullout.....	21
	6.3.4 Bend	21
	6.3.5 Mechanical Strength.....	21
6.4	Markings	21
Section 7	Couplings for Stainless Steel Ground Rod Electrodes	22
7.1	Physical Properties.....	22
	7.1.1 Surface Condition	22
	7.1.2 Material.....	22
7.2	Construction.....	22

7.2.1	Length.....	22
7.2.2	Application Diameter	22
7.3	Performance	23
7.3.1	Conductivity	23
7.3.2	Impact.....	23
7.3.3	Pullout.....	24
7.3.4	Bend	24
7.3.5	Mechanical Strength.....	24
7.4	Markings	24

TABLES

2-1	Finished Diameter Ranges for Copper-Bonded Ground Rod Electrodes	3
2-2	Thread Specifications	4
3-1	Finished Diameter Ranges for Zinc-Coated Ground Rod Electrodes	9
4-3	Thread Specifications	15
5-1	Coupling Thread Sizes For Threaded Copper-Bonded Ground Rod Electrodes.....	16
6-1	Application Diameters for Threadless Couplings for Threadless Zinc-Coated Ground Rod Electrodes... ..	20
7-1	Coupling Thread Sizes for Threaded Stainless Steel Ground Rod Electrodes.....	22

FIGURES

2-1	Thread Specification	4
2-2	End Configuration.....	5
2-3	Apparatus for Straightness Test	7
3-1	End Configuration	10
3-2	Alternative End Configurations.....	12
4-1	End Configuration.....	14

Foreword

This standards publication provides practical information concerning construction, test, performance, and manufacture of ground rod electrodes and ground rod electrode couplings. This standard is intended for use by the electrical industry to provide guidelines for the manufacture and proper application of these products and to promote the benefits of repetitive manufacture and widespread product availability.

One of the primary purposes of this standards publication is to encourage the manufacture and utilization of products, which, in themselves, function in accordance with these standards. While some sections of this publication are intended to eliminate misunderstandings between manufacturers and users, all sections, when applied properly, contribute to safety in one way or another.

The proper manufacture of ground rod electrodes and ground rod electrode couplings is, however, only one consideration in promoting the safe utilization of electricity. Other safety considerations, including environmental conditions, system design, equipment selection and application, installation, operating practices, and maintenance, involve the joint efforts of the system designer, the various equipment manufacturers, the installer, and the user. Information is provided herein to assist in proper selection and use.

Trade Sizes. Trade sizes for copper-bonded, zinc-coated, and stainless steel ground rods and couplings have been a prominent feature of this standard since 1997. Trade size designations are often nominal in character and do not always reflect actual size dimensions.¹ Trade sizes for lumber are perhaps the most well-known example. That has been true over the history of this standard as well. Historically, the diameters of ground rods for copper-bonded, zinc-coated, and stainless steel ground rods have been smaller than their corresponding nominal trade size designations in the standard.

Trade size can serve an important function for manufacturers, customers, and users by providing a convenient means of identifying products and complementary products with certain attributes. In the case of ground rods and this standard, trade size facilitates the identification of ground rods with a certain diameter, the end point configuration of the ground rod, and the identification of couplings that fit with the ground rod sharing a corresponding trade size designation. There are safety and product compatibility interests in facilitating the identification of ground rods and appropriately sized couplings that are intended to work together. Since this standard was first developed in 1997, the tables relating to zinc-coated ground rods changed during each revision, while the tables relating to copper-bonded and stainless steel ground rods have remained relatively unchanged. The changes in the 2005/2007 versions of the standard, in addition to introducing metric measurements for the first time, deleted specific references to certain zinc-coated ground rods and couplings that were commercially available but had slightly smaller dimensions. This version of the standard restores references to those other commercially available zinc-coated ground rods as well as the corresponding couplings and restores the nominal trade size designations in a manner consistent with the nominal trade size designations for copper-bonded and stainless steel ground rods.

The tables below reflect the historical evolution of the trade size designations for zinc-coated ground rods in this standard since 1997. As the reader can see, this standard has historically recognized that trade size designations do not exactly match the actual diameter dimension of the ground rod. The tables for copper-bonded ground rods and stainless steel ground rods demonstrate that the same is true for those ground rods as well. What is new for this version of the standard is that Table 3.1 for zinc-coated ground rods recognizes commercially available zinc-coated ground rod electrodes reflecting a greater variety of

¹ For example, The National Electric Code at Article 90.9 (units of measurement)(2014 ed.) notes that trade size and actual sizes can deviate: Where the actual measured size of a product is not the same as the nominal size, trade size designators shall be used rather than dimensions. Trade practices shall be followed in all cases.

diameters compared to the 2005/2007 version of the standard. This version of the standard also introduces a new measurement for all ground rods: finished rod mean diameter. These additional zinc-coated ground rods and their dimensions (minimum and maximum diameters, end point configuration) and the new finished mean diameter measurement reflect the consensus of NEMA members who developed this version of the standard for each category in Table 3.1. For the benefit of the reader, here are the historical trade size designations since 1997 found in this standard:

NEMA GR1-1997, Table 3.1—Zinc-Coated Ground Rod Electrodes

TRADE SIZE	Diameter Range Inches	
	Minimum	Maximum
1/2	0.50	0.514
5/8	0.60	0.614
3/4	0.725	0.739
1	0.975	0.989

NEMA GR1-2001, Table 3.1—Zinc-Coated Ground Rod Electrodes

TRADE SIZE	Diameter Range Inches	
	Minimum	Maximum
1/2	0.484	0.50
5/8	0.539	0.555
3/4	0.657	0.675

NEMA GR1-2005, Table 3.1—Zinc-Coated Ground Rod Electrodes

TRADE SIZE	Diameter Range Inches and Millimeters			
	Minimum		Maximum	
	mm	in.	mm	in.
5/8	15.88	0.625	16.26	0.640
3/4	19.06	0.750	19.43	0.765
1	25.40	1	25.78	1.015

NEMA GR1-2017, Table 3.1—Zinc-Coated Ground Rod Electrodes

TRADE SIZE	Finished Rod Mean Diameter (inches)	Diameter Range Inches and Millimeters			
		Minimum		Maximum	
		mm	in.	mm	in.
5/8	0.547	13.690	0.539	14.10	0.555
5/8F	0.633	15.880	0.625	16.26	0.640
3/4T	0.666	16.690	0.657	17.15	0.675
3/4	0.735	18.260	0.719	19.05	0.750
3/4F	0.758	19.05	0.750	19.43	0.765
1	1.008	25.40	1	25.78	1.015

The evolution of the 2017 nominal trade size designations for zinc-coated ground rod electrodes from NEMA GR1-2001 to NEMA GR1-2005 to NEMA GR1-2017 can be seen in the table immediately below:

2017 (now)	2005 (previously)	2001 (previously)
5/8	Not included	5/8
5/8F	5/8	Not included
3/4T	Not included	3/4
3/4	Not included	Not included
3/4F	3/4	Not included
1	1	Not included

What is new to Table 3.1 in the 2017 version of the standard, in addition to the additional rows of zinc-coated ground rods, is the use of a suffix, “F” or “T” to identify a variation in diameter among zinc-coated grounds that manufacturers refer to as either “5/8” or “3/4” trade size. Trade sizes without a suffix are nominal trade sizes. The suffix “F” designates a full-minimum diameter size zinc-coated ground rod, and the suffix “T” designates a thinner diameter than the nominal trade size zinc-coated ground rod. Introducing new trade size fractions would have introduced more change from existing commercial practices and created more confusion. The revisions to the nominal trade size designations in Table 3.1 for zinc-coated ground rods may require each manufacturer of zinc-coated ground rods choosing to conform to the standard to make some change to their current trade size designations without causing any one of them to change all their designations. Similar manufacturer changes may occur with respect to designations of ground rod electrode couplings. These changes are a function of expanding the

standard's recognition of all zinc-coated ground rods available in the market. Manufacturers should be able to educate their customers and users about these changes and explain how the trade size designations facilitate identification of ground rods with a particular diameter and the corresponding couplings that should be used with that ground rod.

This standards publication covers design and performance requirements for ground rod electrodes and ground rod electrode couplings, and provides recommendations for their selection and use under normal or certain specific conditions. These standards have been promulgated with a view of promoting safety to persons and property when products conforming to them are selected, installed, and maintained in accordance with the *National Electrical Code*[®] and/or the *National Electrical Safety Code*.

Publication NEMA GR 1 2017 revises and supersedes Publication ANSI/NEMA GR1 2007. NEMA standards publications are periodically reviewed to meet changing conditions and technical progress, and the latest edition should be utilized. Purchasers will be notified as to when revisions take place and will be provided an opportunity to acquire these when available.

Comments from users of this standards publication are welcome. They should be sent to:

Senior Technical Director, Operations
National Electrical Manufacturers Association
1300 North 17th Street, Suite 900
Rosslyn, Virginia 22209

This standards publication was developed by the Electrical Connector Section of the National Electrical Manufacturers Association.

Section approval of the standard does not necessarily imply that all section members voted for its approval or participated in its development. At the time it was approved, the Electrical Connector Section was composed of the following members:

South Atlantic, LLC

Sicame Corporation

Burndy LLC

MacLean Power

ILSCO Corporation

Pentair Engineered Electrical & Fastening
Solutions

TYCO Electronics Corporation

Cooper Power Systems by Eaton

Galvan Industries, Inc.

Harger Lightning & Grounding

AFL

Prysmian Cables & Systems

Panduit Corporation

Thomas & Betts, A Member of the ABB Group

3M Austin Center

Section 1 General

1.1 Scope

This standards publication applies to ground rod electrodes and ground rod electrode couplings that function in accordance with the *National Electrical Code*[®] (NFPA 70-2014) and/or the *National Electrical Safety Code* (ANSI C2-2012). Included are materials, construction, and performance of copper-bonded ground rod electrodes, zinc-coated ground rod electrodes, and stainless steel ground rod electrodes. This standards publication also includes information for electrode products that have been successfully used for many years but are not defined within the *National Electrical Code*[®] or the *National Electrical Safety Code*. The items described in this standards publication are defined in Section 1.

1.2 Normative References

This NEMA standards publication represents the results of research and investigation by the members of NEMA, its sections, and its committees. It has been developed through consultation among manufacturers, users, and national engineering societies. This publication references the following standards (all referenced documents use the latest document date):

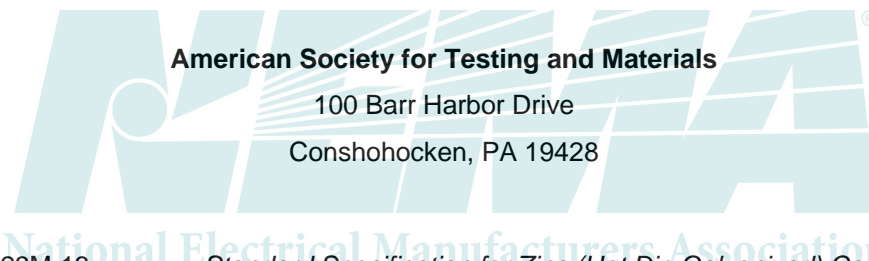

ASTM A123/A123M-13	<i>Standard Specification for Zinc (Hot Dip Galvanized) Coatings of Iron and Steel Products</i>
ASTM A153/A153M-09	<i>Standard Specification for Zinc Coatings (Hot-Dip) on Iron and Steel Hardware</i>
ASTM A276-06	<i>Standard Specification for Stainless Bars and Shapes</i>
ASTM A370-12a	<i>Standard Test Methods and Definitions for Mechanical Testing of Steel Products</i>
ASTM E376-11	<i>Standard Practice for Measuring Coating Thickness by Magnetic-Field or Eddy-Current (Electromagnetic) Test Methods</i>

Institute of Electrical and Electronic Engineers

445 Hoes Lane
Piscataway, NJ 08854

ANSI/IEEE C2-2012	<i>National Electrical Safety Code</i>
-------------------	--

National Fire Protection Association, Inc.

One Batterymarch Park
Quincy, MA 02169

ANSI/NFPA 70-2014

National Electrical Code[®]

Underwriters Laboratories, Inc.

333 Pfingsten Road
Northbrook, IL 60062

ANSI/UL 467-2013

Standard for Grounding and Bonding Equipment

1.3 Units of Measurement

The primary units of measure in this standards publication are based on the metric dimensions with conventional inch—pound system in parentheses, which is commonly accepted and used by the electrical construction industry.

1.4 Definitions

adhesion: The physical bond between the applied metal and the core metal.

copper bond: The physical bond between the copper and the core metal.

coupling: A connecting device for mechanically and electrically joining two ground rod electrodes in series.

ground rod electrode: A rod type device that establishes an electrical connection to the earth and is capable of being driven.

zinc coating: The layer of zinc around the core metal.

Section 2 Copper-Bonded Ground Rod Electrodes

2.1 Steel Core Properties

Upon inspection of the steel core, there shall be minimal signs of pitting and erosion. There shall be no gashes or cracks that protrude slivers from the surface of the electrode. The steel core, when tested in accordance with ASTM A370, shall have a tensile strength of not less than 552 MPa (80,000 lbs. per square-inch) and a Rockwell hardness of no less than B80.

2.2 Copper Thickness

The copper thickness shall not be less than 0.25 mm (0.010 in.) for ground rod electrodes 12.7 mm (0.50 in.) or greater in diameter. The copper thickness shall be measured with a properly calibrated eddy-current (electromagnetic) device. The device shall be used in accordance with the manufacturer's instructions, and by following the standard practice for measuring coating thickness described in ASTM E376.

2.3 Length

Ground rod electrodes shall have a minimum total length of 2.44 m (8 ft.). They shall have a length as specified with a -0 tolerance.

2.4 Ground Rod Electrode Diameters

Finished ground rod electrodes for the trade sizes listed in Table 2-1 shall be cold drawn and fall within the specified finished diameter ranges.

Table 2-1 Finished Diameter Ranges for Copper-Bonded Ground Rod Electrodes

		Finished Diameter Range			
		Threaded and Threadless			
Trade Size	Finished Rod Mean Diameter	Minimum		Maximum	
	(in.)	mm	(in.)	mm	(in.)
1/2	0.504	12.7	0.5	12.9	0.507
5/8	0.56	14.1	0.555	14.35	0.565
3/4	0.678	17.09	0.673	17.35	0.683
1	0.912	23.04	0.907	23.29	0.917

Note: Rods less than 0.625 in. shall be certified to a nationally recognized standard to comply with the *National Electrical Code*[®]/ANSI NFPA 70.

2.5 Threads

Threads on copper bonded, sectional type ground rod electrodes shall be rolled onto both ends after copper bonding and shall conform to the specifications in Figure 2-1 and Table 2-2.

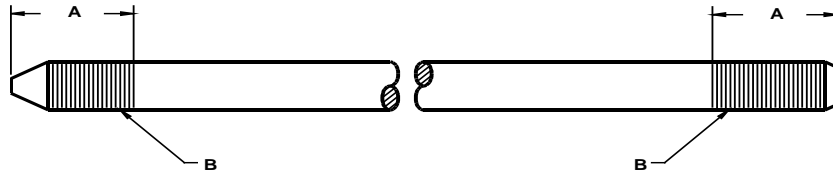

Figure 2-1 Thread Specification

Table 2-2 Thread Specifications

Trade Size	Finished Rod Mean Diameter	Dimension A		Thread B Profile
		mm (+3.2, -1.6)	in. (+1/8, -1/16)	
	(in.)			UNC
1/2	0.504	26.99	1-1/16	9/16 - 12
5/8	0.56	30.16	1-3/16	5/8 - 11
3/4	0.678	31.75	1-1/4	3/4 - 10
1	0.912	42.86	1-11/16	1 - 8

2.6 End Configurations

The end configurations of a copper-bonded ground rod electrode shall be in accordance with Figure 2-2. The diameter of the penetrating (pointed) end of a copper-bonded ground rod electrode shall be as specified per Dimension A, of Table 2-3, for each trade size. The length of the chamfer on the driving (blunt) end shall be as specified per Dimension B of Table 2-3.

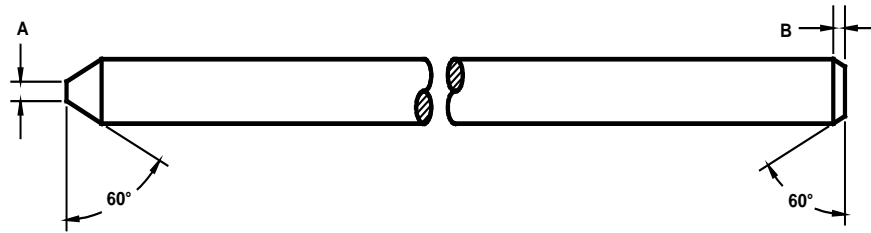

**Figure 2-2
End Configuration**

**Table 2-3
End Point Configurations**

Trade Size	Finished Rod Mean Diameter (in)	Dimension A (Maximum)		Dimension B (Minimum)	
		mm	(in.)	mm	(in.) [®]
1/2	0.504	4.76	3/16	2.38	3/32
5/8	0.56	4.76	3/16	3.18	1/8
3/4	0.678	6.35	1/4	3.18	1/8
1	0.912	9.53	3/8	5.56	7/32

2.7 Adhesion

2.7.1 Test Method

An 18 in. length of ground rod electrode with one end cut to a 45 degree point shall be driven between two steel clamping plates or the jaws of a vise set 0.04 in. less than the diameter of the ground rod electrode, so as to shear off sufficient metal to expose the bond between the copper and the ground rod electrode.

2.7.2 Evaluation of Adhesion

There shall be no evidence of separation of the copper and the steel core.

2.8 Ductility

2.8.1 Test Method

At room temperature ($25^{\circ} \pm 5^{\circ}\text{C}$), a length of ground rod electrode shall be rigidly held in a clamp or vise and the free end bent by applying a force normal to the ground rod electrode at a distance from the clamping device equal to 40 times the ground rod electrode diameter. The magnitude of the force and the direction of application shall be such that the ground rod electrode is permanently bent through a 30-degree angle.

2.8.2 Evaluation of Ductility

Upon visual inspection with no magnification, there shall be no evidence of cracking of the copper.

2.9 Finish

The surface of a ground rod electrode shall be smooth and free from blisters, slivers, and other types of projections.

2.10 Straightness

The deviation from straight for any ground rod electrode shall be determined and evaluated in accordance with the following:

2.10.1 Test Method

The selected ground rod electrode shall be supported by two "V" blocks, with a dial feeler gage located at the mid-point of the "V" blocks in accordance with Figure 2-3. While rotating the ground rod electrode by hand, the maximum and minimum readings shall be recorded. The readings are then subtracted for the total deviation. The average deviation from straight for the length of the ground rod electrode located between the "V" blocks is determined by the following formula:

$$\text{Average Deviation} = \frac{\text{Maximum Deviation (inches)} + \text{Minimum Deviation (inches)}}{2}$$

2.10.2 Evaluation of Straightness

Straightness of the ground rod electrode shall not vary more than 6.4 mm (0.25 in.) in. 1.5 m (5 ft.).

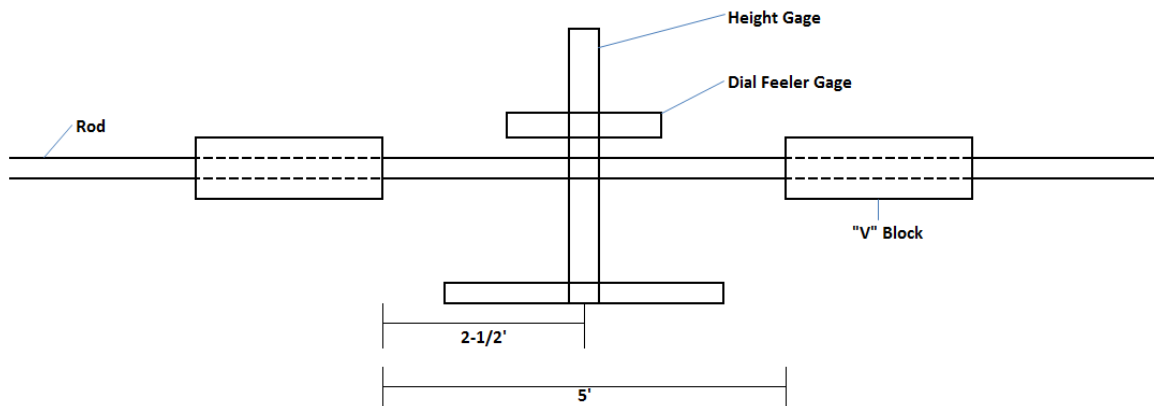
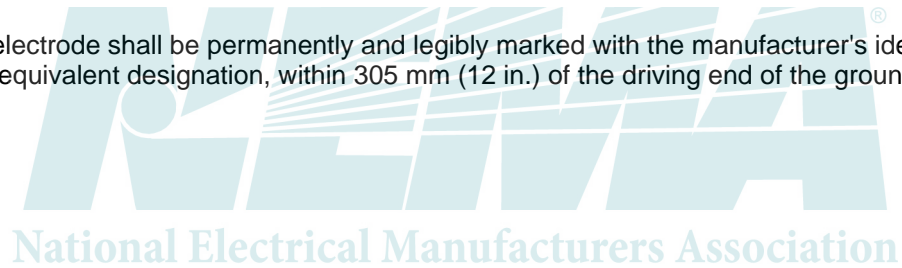

Figure 2-3
Apparatus for Straightness Test

2.11 Markings

A ground rod electrode shall be permanently and legibly marked with the manufacturer's identification and the catalog or equivalent designation, within 305 mm (12 in.) of the driving end of the ground rod electrode.



Section 3

Zinc-Coated Ground Rod Electrodes

3.1 Steel Core Properties

Upon inspection of the steel core, there shall be minimal signs of pitting and erosion. There shall be no gashes or cracks that protrude slivers from the surface of the ground rod electrode. The steel core, when tested in accordance with ASTM A370, shall have a tensile strength of not less than 552 MPa (80,000 PSI) and a Rockwell hardness of no less than B80.

3.2 Zinc Coating

3.2.1 Coating Method

All ground rod electrodes manufactured in accordance with this section shall be coated utilizing a method in accordance with applicable ASTM standards. Hot dip galvanized ground rod electrodes shall be manufactured in accordance with ASTM A123 or ASTM A153.

3.2.2 Thickness

The zinc deposit thickness shall not be less than 0.099 mm (0.0039 in.) for an ASTM A123 ground rod electrode or 0.086 mm (0.0034 in.) for an ASTM A153 ground rod electrode.

3.2.3 Measurement

The measurement for zinc thickness shall be made with a properly calibrated eddy-current (electromagnetic) device. The device shall be used in accordance with the manufacturer's instructions, and by following the standard practice for measuring coating thickness described in ASTM E376.

3.3 Length

Ground rod electrodes shall have a minimum total length of 2.44 m (8 ft.). They shall have a length as specified with a -0 tolerance.

National Electrical Manufacturers Association

3.4 Ground Rod Electrode Diameters

Finished ground rod electrodes shall fall within the specified diameter ranges as specified in Table 3-1.

Table 3-1
Finished Diameter Ranges for Zinc-Coated Ground Rod Electrodes

Trade Size	Finished Rod Mean Diameter (in)	Finished Diameter Range			
		Minimum Diameter		Maximum Diameter	
		(mm)	(in)	(mm)	(in)
5/8	0.547	13.690	0.539	14.100	0.555
5/8F	0.633	15.880	0.625	16.260	0.640
3/4T	0.666	16.690	0.657	17.150	0.675
3/4	0.735	18.260	0.719	19.050	0.750
3/4F	0.758	19.050	0.750	19.430	0.765
1	1.008	25.400	1.000	25.780	1.015

Note: Rods less than 0.625 in. shall be certified to a nationally recognized standard to comply with the *National Electrical Code*[®]/ANSI NFPA 70.

For purposes of Table 3-1, “F” is used to designate a ground rod with a minimum diameter corresponding to the actual trade size shown. The letter “T” is used to designate a ground rod with a thinner finished rod mean diameter than the ¾ trade size ground rod. Corresponding designations are made in Tables 3-2 and 6-1. NOTICE: Trade size designations have changed from the previous version of this standard due to the enlargement in the number of ground rods referenced in this Table. See summary of revisions to trade size designations in Foreword under heading “Trade Size.” Users should ensure that couplings with measurements described in Table 6-1 should be used with the corresponding trade size for ground rods referenced in this Table 3-1.

3.5 Adhesion

The zinc coating shall withstand handling consistent with the nature and thickness of the coating and the normal use of the ground rod electrode without peeling or flaking.

3.5.1 Test Method

Proper adhesion of the zinc coating to the base metal surface shall be determined by cutting or prying the coating with the point of a stout knife, applied with a pressure sufficient to remove a portion of the coating.

3.5.2 Evaluation of Adhesion

Adhesion shall be considered inadequate if flaking occurs, exposing the base metal in advance of the knife point. Adhesion shall not be evaluated at edges or corners. There shall be no evidence of separation of the zinc and the steel core.

3.6 Finish

The surface of ground rod electrodes shall be uniform in appearance, clean, and free of visible coating defects, such as blisters, flux, inclusions, pits, roughness, slivers, sharp spikes, nodules, bare spots, burning, cracks, or unplated areas, and other defects that may affect function of the coating. The coating shall not be stained or discolored. However, superficial staining that results from rinsing or slight discoloration resulting from any drying or baking operation to relieve hydrogen embrittlement shall be acceptable.

3.7 Straightness

The deviation from straight for any ground rod electrode shall be determined and evaluated as follows:

3.7.1 Test Method

Ground rod electrodes shall be prepared for straightness testing in accordance with 2.10.1.

3.7.2 Evaluation of Straightness

Straightness of the ground rod electrode shall not vary more than 6.4 mm (0.25 in.) in 1.5 m (5 ft.) for any 1.5 m (5 ft.) section of rod.

3.8 End Configurations

End configurations of a zinc-coated ground rod electrode shall be in accordance with Figure 3-1. A four-sided nail type point with the same 60° angle on each side of the point shall be acceptable. Alternative end configurations as illustrated in Figure 3-2 shall also be acceptable. The diameter of the penetrating (pointed) end of the zinc-coated ground rod electrode shall be as specified per Dimension A of Table 3-2 for each trade size. The length of the optional chamfer, Figure 3-1, on the driving (blunt) end shall be as specified per Dimension B of Table 3-2.

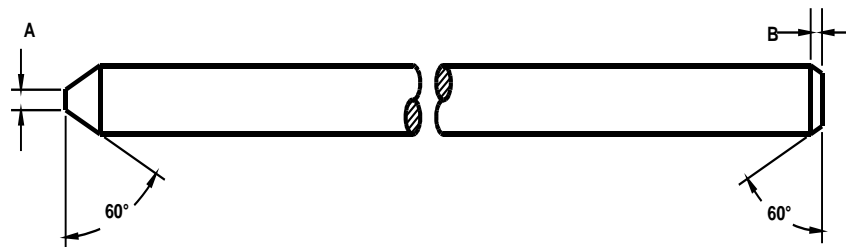
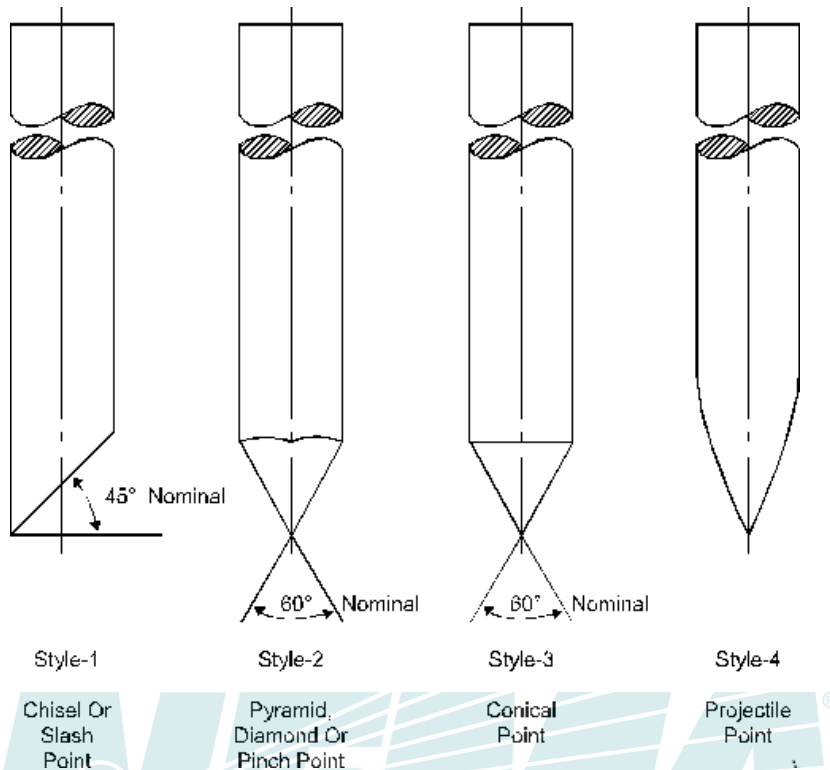

Figure 3-1
End Configuration

**Table 3-2
End Point Configurations**

Trade Size	Finished Rod Mean Diameter (in)	Diameter of End Points			
		Dimension A		Dimension B	
		Maximum		Minimum	
		mm	(in.)	mm	(in.)
5/8	0.547	4.76	3/16	2.38	3/32
5/8F	0.633	4.76	3/16	3.18	1/8
3/4T	0.666	6.35	1/4	3.18	1/8
3/4	0.735	6.35	1/4	3.18	1/8
3/4F	0.758	6.35	1/4	3.18	1/8
1	1.008	9.53	3/8	5.56	7/32

For purposes of Table 3-2, "F" is used to designate a ground rod with a minimum diameter corresponding to the actual trade size as shown in Table 3-1. The letter "T" is used to designate a ground rod with thinner finished rod mean diameter than the 3/4 trade size ground rod. Corresponding designations are made in Tables 3-1 and 6-1. NOTICE: trade size designations have changed from the previous version of this standard. See summary of revised trade size designations in Foreword under heading "Trade Size."



Style-1 Chisel Or Slash Point
Style-2 Pyramid, Diamond Or Pinch Point
Style-3 Conical Point
Style-4 Projectile Point[®]

Figure 3-2
Alternative End Configurations

National Electrical Manufacturers Association

3.9 Markings

Ground rod electrodes shall be permanently and legibly marked with the manufacturer's identification and the catalog or equivalent designation within 305 mm (12 in.) of the driving end of the ground rod electrode.

Section 4 Stainless Steel Ground Rod Electrodes

4.1 Steel Properties

Stainless steel ground rod electrodes Grade 304 conform to ASTM A276.

The stainless steel rod, when tested in accordance with ASTM A370, shall have a tensile strength of no less than 795 MPa (115,305 PSI).

4.2 Length

Ground rod electrodes shall have a minimum total length of 2.44 m (8 ft.). They shall have a length as specified with a -0 tolerance.

4.3 Ground Rod Electrode Diameters

Finished ground rod electrodes for the trade sizes listed in Table 4-1 shall fall within the specified diameter ranges.

**Table 4-1
Finished Diameter Ranges for Solid Stainless Steel
Ground Rod Electrodes**

Trade Size	Finished Rod Mean Diameter	Finished Diameter Ranges			
		Minimum		Maximum	
	(in.)	mm	(in.)	mm	(in.)
1/2	0.504	12.7	0.5	12.88	0.507
5/8	0.63	15.88	0.625	16.13	0.635
3/4	0.758	19.05	0.75	19.43	0.765
1	1.008	25.4	1	25.78	1.015

Note: Rods less than 0.625 in. shall be certified to a nationally recognized standard to comply with the *National Electrical Code*[®]/ANSI NFPA 70.

4.4 Finish

The surface of ground rod electrodes shall be uniform in appearance, clean, and free of visible defects. Superficial staining shall be acceptable.

4.5 Straightness

The deviation from straight for any ground rod electrode shall be determined and evaluated as follows:

4.5.1 Test Method

Ground rod electrodes shall be prepared for straightness testing in accordance with 2.10.1.

4.5.2 Evaluation

Straightness of the ground rod electrode shall not vary more than 6.4 mm (0.25 in.) in 1.5 m (5 ft.) for any 1.5 m (5 ft.) section of rod.

4.6 End Configurations

The diameter of the penetrating (pointed) end of the stainless steel ground rod electrode shall be as specified per Dimension A, of Figure 4-1 and Table 4-2 for each trade size. The length of the optional chamfer, Figure 4-1, on the driving (blunt) end shall be as specified per Dimension B of Table 4-2.

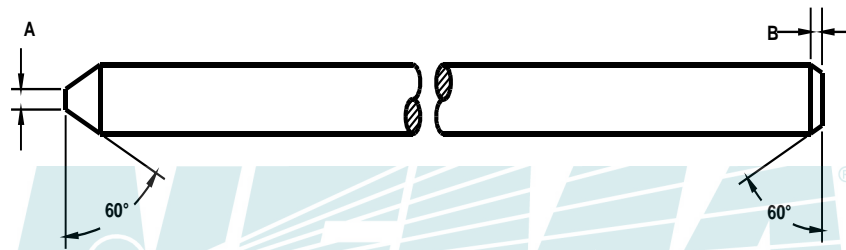

Figure 4-1
End Configuration

Table 4-2
End Configuration

Trade Size	Finished Rod Mean Diameter	Diameter of End Points			
		Dimension A		Dimension B	
		Maximum		Minimum	
	(in.)	mm	(in.)	mm	(in.)
1/2	0.504	4.76	3/16	2.38	3/32
5/8	0.630	4.76	3/16	3.18	1/8
3/4	0.758	6.35	1/4	3.18	1/8
1	1	9.53	1/8	5.56	7/32

4.7 Markings

A ground rod electrode shall be permanently and legibly marked with the manufacturer's identification, and the catalog or equivalent designation within 305 mm (12 in.) of the driving end of the ground rod electrode.

4.8 Threads

Threads on stainless steel, sectional type ground rod electrodes shall be cut threads on both ends and shall conform to the specifications in Figure 4-2 and Table 4-3.

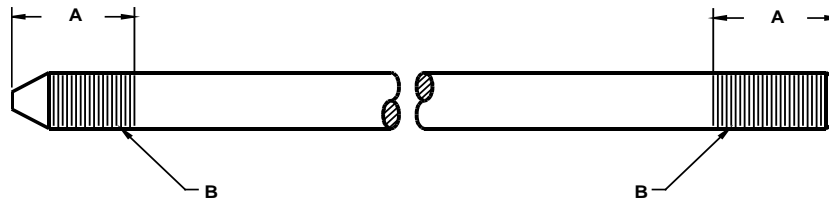

Figure 4-2
Thread Specification

Table 4-3
Thread Specifications

Trade Size	Finished Rod Mean (in.)	Dimension A		Thread B Profile
		mm (+3.2, -1.6)	in. (+1/8, -1/16)	
1/2	0.504	26.99	1-1/16	9/16-12-1/2 – 13 cut
5/8	0.63	30.16	1-3/16	5/8-11 – 11 cut
3/4	0.758	31.75	1-1/4	3/4-10-3/4 – 10 cut
1	1.008	42.86	1-11/16	1-8 cut

Section 5 Couplings for Copper-Bonded Ground Rod Electrodes

5.1 Physical Properties

5.1.1 Surface Condition

The surface of the coupling shall be smooth and free of cracks, burrs, or sharp corners.

5.1.2 Material

Coupling material shall be copper or a copper alloy containing not less than 80% copper and shall be suitable for burial in earth.

5.2 Construction

5.2.1 Length

The length of threaded couplings shall be sufficient to cover the threaded portion of two coupled ground rod electrodes. In addition, the lengths of both threaded and threadless couplings shall be sufficient to meet the performance requirements of section 5.3 of this standard.

5.2.2 Application Diameter

5.2.2.1 Threaded Ground Rod Electrode Couplings

A threaded coupling shall be symmetrical and shall accept threaded ground rod electrodes of the trade sizes in Table 5-1.

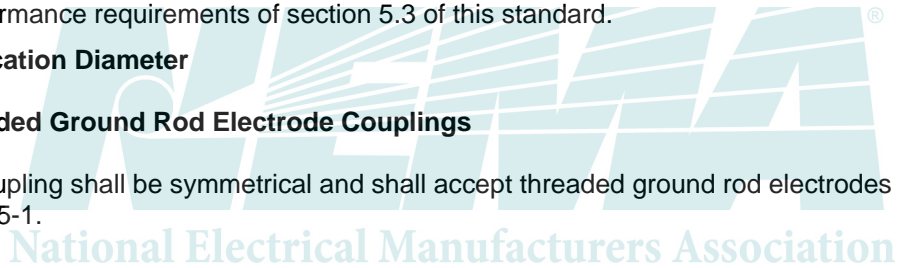

**Table 5-1
Coupling Thread Sizes For Threaded
Copper-Bonded Ground Rod Electrodes**

Trade Size	Thread Profile
1/2	9/16-12
5/8	5/8-11
3/4	3/4-10
1	1-8

5.2.2.2 Threadless Ground Rod Electrode Couplings

A threadless ground rod electrode coupling shall be symmetrical and shall accept threadless ground rod electrodes of the trade sizes in Table 5-2.

**Table 5-2
Application Diameters For Threadless Couplings for
Threadless Copper-Bonded Ground Rod Electrodes**

Trade Size	Application Diameter	
	mm	(in.)
1/2	12.70–12.95	0.500–0.507
5/8	14.10–14.35	0.555–0.565
3/4	17.09–17.35	0.673–0.683
1	23.04–23.29	0.907–0.917 [®]

5.3 Performance

5.3.1 Conductivity

When used to join two copper-bonded ground rod electrodes of the minimum diameters specified in Table 2-1, couplings shall provide no less than 95% of the conductivity of an unspliced copper-bonded ground rod electrode of equal length.

5.3.2 Impact

5.3.2.1 Test Method

Two 460 mm (18 in.) lengths of copper-bonded ground rod electrodes of the diameters specified in Table 2-1 shall be coupled and held vertically in a tubular fixture that is at least 0.25 mm (0.010 in.) greater than the copper-bonded ground rod electrode diameter. The penetrating end of the bottom ground rod electrode shall be rested on a fixed plate of a weight sufficient to withstand the test impact, and located in a hole at least 100 mm (4 in.) in depth. The coupling shall not rest on or be contained within the tubular fixture or the fixed plate. The top ground rod electrode shall be subjected to an impact energy of 54 J (40 ft.-lb.) imparted by a dropped mass.

5.3.2.2 Evaluation

After 25 impacts, there shall be no evidence of breakage, splitting, or damage that impairs the performance of the coupling.

5.3.3 Pullout

When used to join two copper-bonded ground rod electrodes of the minimum diameters specified in Table 2-1, the joining coupling and copper-bonded ground rod electrodes must withstand a pullout force of no less than 6.7 kN (1500 lbf) before separation.

5.3.4 Bend

5.3.4.1 Test Method

Two copper-bonded ground rod electrodes coupled together shall be subjected to the same bending requirements as an individual ground rod electrode. The test specimen shall be gripped in a suitable rigid clamp or vise and the ground rod electrode bent by applying a force normal to the ground rod electrode, at a distance of 40 times the ground rod electrode diameter from the clamping device. The coupling shall be located midway between the clamping device and the point of applied force. The force shall be applied until the ground rod electrode is permanently bent through an angle of 30°.

5.3.4.2 Evaluation

The coupling shall not exhibit any signs of cracking or separation from the ground rod electrode.

5.3.5 Mechanical Strength

Couplings shall provide sufficient mechanical strength to permit driving under normal conditions and not exhibit deformation or splitting under such conditions. This is demonstrated by successful compliance to sections 5.3.2 through 5.3.4.

5.4 Markings

Each coupling shall be marked with the manufacturer's name or trademark and trade size. Each container, packaged as required by the end user, shall be marked with the manufacturer's name or trademark, and trade size.

Section 6 Couplings for Zinc-Coated Ground Rod Electrodes

6.1 Physical Properties

6.1.1 Surface Condition

The surface of the coupling shall be smooth and free of cracks, burrs, or sharp corners.

6.1.2 Material

Coupling material shall be zinc-coated steel or stainless steel.

Material characteristics shall include the following:

Tensile Strength: 483 MPa Minimum (70,000 PSI)

Yield strength: 380 MPa Minimum (55,000 PSI)

% Elongation 2 in.: 10%

6.2 Construction

6.2.1 Length

The length of the threadless coupling shall be a minimum of 69.85 mm (2-3/4 in.). In addition, the lengths of threadless couplings shall be sufficient to meet the performance requirements of section 6.3 of this standard.

6.2.2 Threadless Ground Rod Electrode Couplings

A threadless zinc-coated ground rod electrode coupling shall be symmetrical and shall accept a plain threadless zinc-coated ground rod electrode of the specified diameter ranges in Table 6-1.

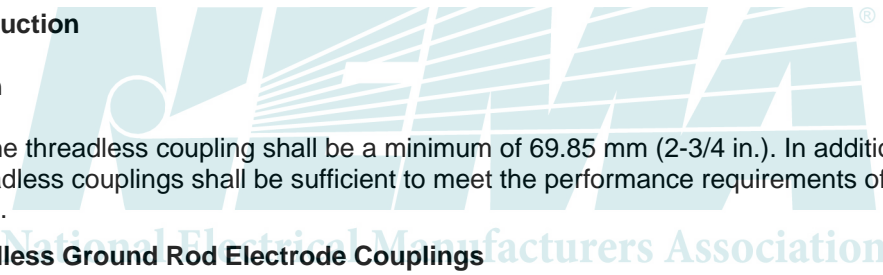

Table 6-1 Application Diameters for Threadless Couplings for Threadless Zinc-Coated Ground Rod Electrodes			
<i>Trade Size</i>	Finished Rod Mean Diameter	Application Diameter	
		(mm)	(in.)
5/8	0.547	13.69–14.10	0.539–0.555
5/8F	0.633	15.88–16.26	0.625–0.640
3/4T	0.666	16.69–17.15	0.657–0.675
3/4	0.735	18.26–19.05	0.719–0.750
3/4F	0.758	19.05–19.43	0.750–0.765
1	1.008	25.4–25.78	1.000–1.015

For purposes of Table 6-1, “F” is used to designate a ground rod with a minimum diameter corresponding to the actual trade size as shown in Table 3-1. The letter “T” is used to designate a ground rod with thinner finished rod mean diameter. Corresponding designations are made in Tables 3-1 and 3-2. NOTICE: trade size designations have changed from the previous version of this standard. See summary of revisions to trade size designations in the Foreword under heading “Trade Size.”

National Electrical Manufacturers Association

6.3 Performance

6.3.1 Conductivity

When used to join two zinc-coated ground rod electrodes of the minimum diameters specified in Table 3-1, couplings shall provide to joined ground rod electrodes, no less than 95% of the conductivity of an unspliced zinc-coated ground rod electrode of equal length.

6.3.2 Impact

6.3.2.1 Test Method

Two 450 mm (18 in.) zinc-coated ground rod electrodes of the diameters specified in Table 3-1, shall be coupled and held vertically in a tubular fixture that is at least 0.010 in. greater than the zinc-coated ground rod electrode diameter. The penetrating end of the bottom ground rod electrode shall be rested on a fixed plate of a weight sufficient to withstand the test impact, and located in a hole at least 100 mm (4 in.) in depth. The coupling shall not rest on or be contained within the tubular fixture or the fixed plate. The top ground rod electrode shall be subjected to an impact energy of 54 J (40 ft-lb).

6.3.2.2 Evaluation

After 25 impacts, there shall be no evidence of breakage, splitting, or damage that impairs the performance of the coupling.

6.3.3 Pullout

When used to join two zinc-coated ground rod electrodes of the minimum diameters specified in Table 3-1, the joining coupling and zinc-coated ground rod electrodes must withstand a pullout force of no less than 6.7 kN (1500 lbf) before separation.

6.3.4 Bend

6.3.4.1 Test Method

Two zinc-coated ground rod electrodes coupled together shall be subjected to the same bending requirements as an individual ground rod electrode. The test specimen shall be gripped in a suitable rigid clamp or vise and the ground rod electrode bent by applying a force normal to the ground rod electrode, at a distance of 40 times the ground rod electrode diameter from the clamping device. The coupling shall be located midway between the clamping device and the point of applied force. The force shall be applied until the ground rod electrode is permanently bent through an angle of 30°.

6.3.4.2 Evaluation

The coupling shall not exhibit any signs of cracking or separation from the ground rod electrode.

6.3.5 Mechanical Strength

Couplings shall provide sufficient mechanical strength to permit driving under normal conditions, and not exhibit deformation or splitting under such conditions. This is demonstrated by successful compliance to sections 6.3.2 through 6.3.4.

6.4 Markings

Each coupling shall be marked with the manufacturer's name or trademark and trade size. Each container, packaged as required by the end user, shall be marked with the manufacturer's name or trademark, and trade size.

National Electrical Manufacturers Association

Section 7 Couplings for Stainless Steel Ground Rod Electrodes

7.1 Physical Properties

7.1.1 Surface Condition

The surface of the coupling shall be smooth and free of cracks, burrs, or sharp corners.

7.1.2 Material

Coupling material shall be of Grade 304 stainless steel.

7.2 Construction

7.2.1 Length

The length of the stainless steel coupling shall be a minimum of 69.85 mm (2-3/4 in.). In addition, the lengths of stainless steel couplings shall be sufficient to meet the performance requirements of section 7.3.

7.2.2 Application Diameter

7.2.2.1 Threaded Ground Rod Electrode Couplings

A threaded stainless steel coupling shall be symmetrical and shall accept threaded stainless steel ground rod electrodes threads of the trade sizes in Table 7-1.

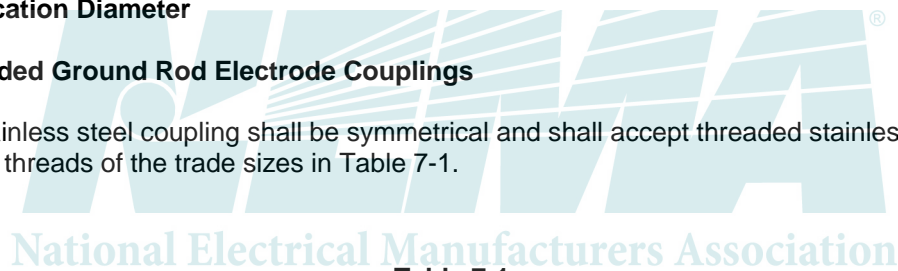

Table 7-1
**Coupling Thread Sizes for Threaded
Stainless Steel Ground Rod Electrodes**

Trade Size	Thread Profile
1/2	9/16-12
5/8	5/8-11
3/4	3/4-10
1	1-8

7.2.2.2 Threadless Ground Rod Electrode Couplings

A threadless stainless steel ground rod electrode coupling shall be symmetrical and shall accept a plain threadless stainless steel ground rod electrode of the trade sizes in Table 7-2.

**Table 7-2
Application Diameters for Threadless Couplings For
Threadless Stainless Steel Ground Rod Electrodes**

Trade Size	Application Diameter	
	mm	(in.)
1/2	12.7–12.90	0.500–0.507
5/8	15.87–16.25	0.625–0.640
3/4	19.05–19.43	0.750–0.765
1	25.40–25.78	1.000–1.015

7.3 Performance

The threadless coupler for a stainless steel ground rod must be able to seat on the rod with minimal impacting force, be able to withstand such impacting forces so as not to break or split, and have sufficient opening to allow for variation in rod size due to manufacturing process or some deforming as a result of driving ground rods.

7.3.1 Conductivity

When used to join two stainless steel ground rod electrodes of the minimum diameters specified in Table 7-1, couplings shall provide to joined ground rod electrodes, no less than 95% of the conductivity of an unspliced stainless steel ground rod electrode of equal length.

7.3.2 Impact

7.3.2.1 Test Method

Two 450 mm (18 in.) stainless steel ground rod electrodes of the diameters specified in Table 7-1, shall be coupled and held vertically in a tubular fixture that is at least 0.25 mm (0.010 in.) greater than the stainless steel ground rod electrode diameter. The penetrating end of the bottom ground rod electrode shall be rested on a fixed plate of a weight sufficient to withstand the test impact, and located in a hole at least 100 mm (4 in.) in depth. The coupling shall not rest on or be contained within the tubular fixture or the fixed plate. The top ground rod electrode shall be subjected to an impact energy of 54 J (40 ft-lb.).

7.3.2.2 Evaluation

After 25 impacts, there shall be no evidence of breakage, splitting, or damage that impairs the performance of the coupling.

7.3.3 Pullout

When used to join two stainless steel ground rod electrodes of the minimum diameters specified in Table 4-1, the joined coupling and stainless steel ground rod electrodes must withstand a pullout force of no less than 6.7 kN (1500 lbf) before separation.

7.3.4 Bend

7.3.4.1 Test Method

Two stainless steel ground rod electrodes coupled together shall be subjected to the same bending requirements as an individual ground rod electrode. The test specimen shall be gripped in a suitable rigid clamp or vise and the ground rod electrode bent by applying a force normal to the ground rod electrode, at a distance of 40 times the ground rod electrode diameter from the clamping device. The coupling shall be located midway between the clamping device and the point of applied force. The force shall be applied until the ground rod electrode is permanently bent through an angle of 30°.

7.3.4.2 Evaluation

The coupling shall not exhibit any signs of cracking or separation from the ground rod electrode.

7.3.5 Mechanical Strength

Couplings shall provide sufficient mechanical strength to permit driving under normal conditions, and not exhibit deformation or splitting under such conditions. This is demonstrated by successful compliance to sections 7.3.2 through 7.3.4.

7.4 Markings

Each coupling shall be marked with the manufacturer's name or trademark and trade size. Each container, packaged as required by the end user, shall be marked with the manufacturer's name or trademark, and trade size.

§